

4

3

2

1

B

B

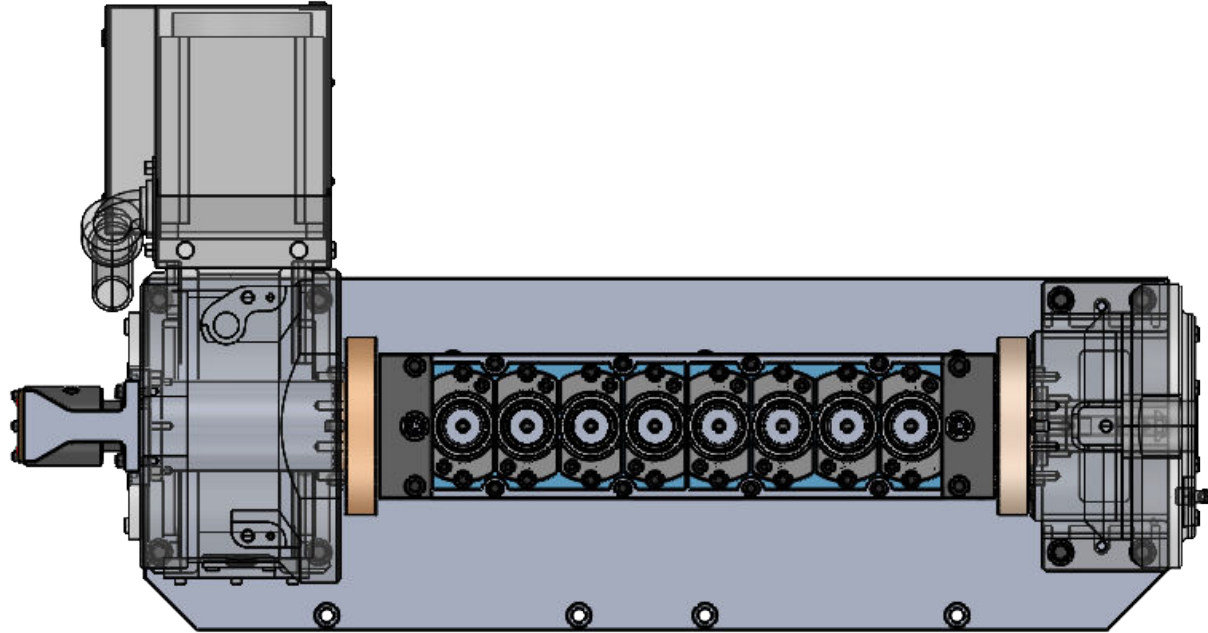
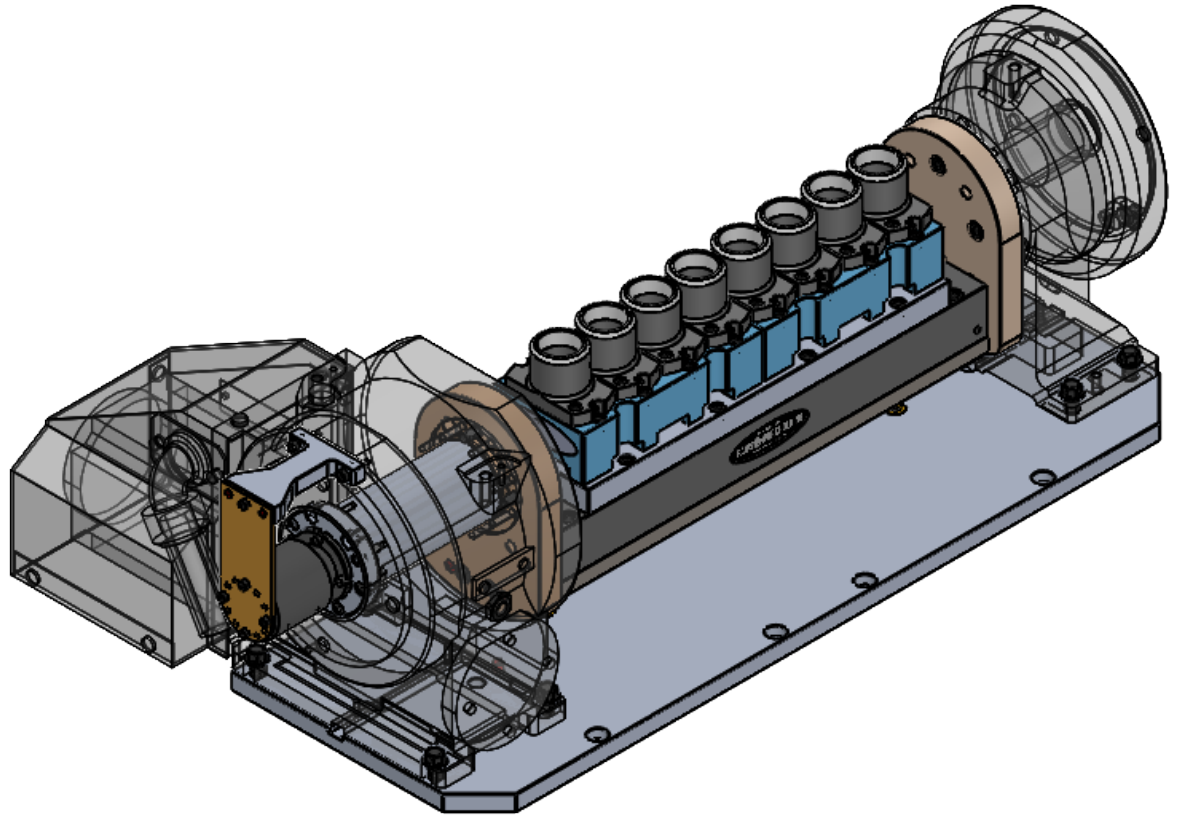

A

A

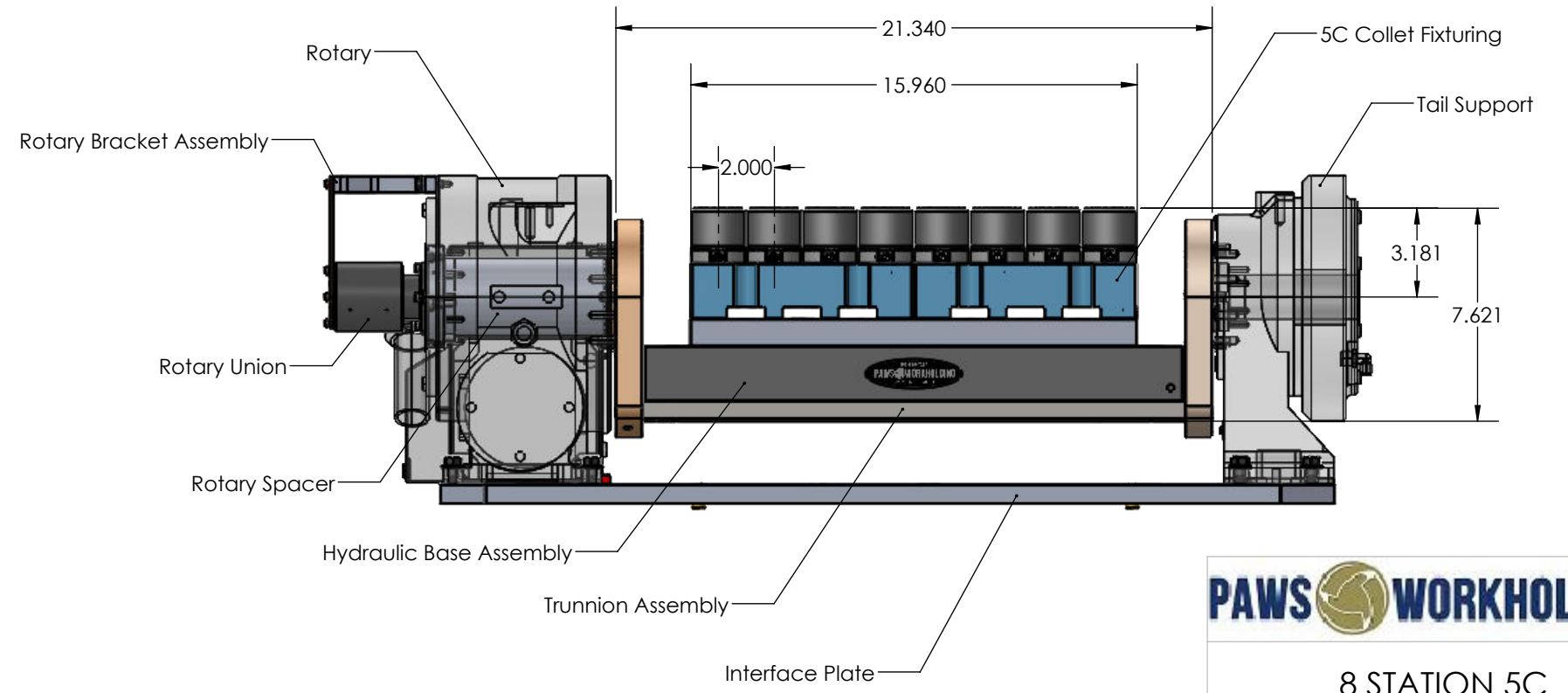
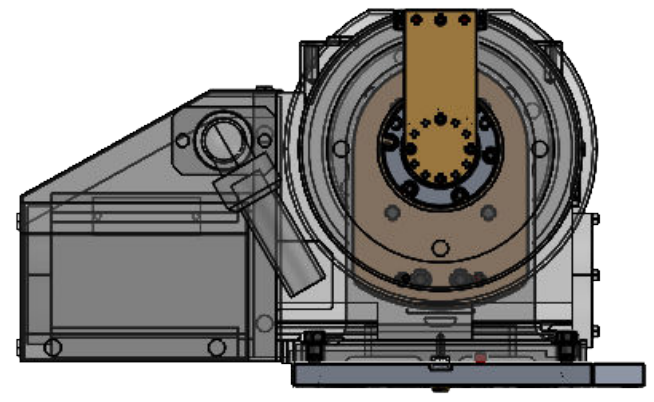

8 STATION 5C
TRUNNION COLLET SYSTEM

DWG. NO.	REV A
----------	-----------------

4

3

2

1